

Balance Regulating Valves

Ideal Hydraulic Balance Solution

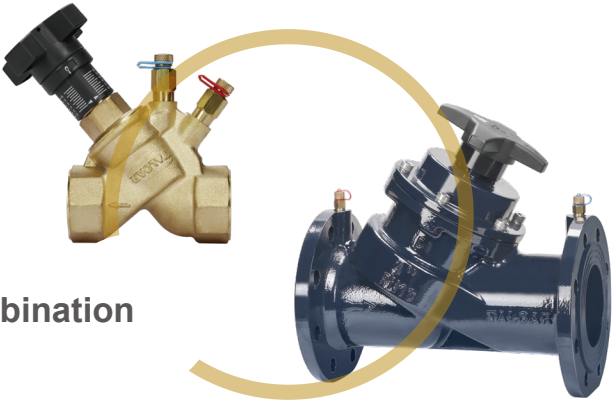

Global Flow Control Combination

TALOAR[®]

TALOAR INC
FLUID SYSTEMS, 2023



HVAC Hydraulic Balance Solution



TALOAR Global Flow Control Combination

TALOAR INC serves as a world-leading supplier of flow control products and services, providing a series of diversified fluid control products that are dedicated to commercial, water-related and industrial applications. Our product lines cover universal manual valves, fire protection valves, water control valves, balance valves and electric control valves including industrial ball valves, butterfly valves and gauge valves. Part of the products already obtained the world's most authoritative UL, FM and API certificates. TALOAR currently offers more than 12,000 items manual operated, automatic operated, under high temperature, low temperature or severe conditions, TALOAR performs its superb product quality to ensure your running system is safe and sound.

IN PRODUCTION

As usual TALOAR incorporates the latest mechanical technologies and advanced automation systems to produce and deliver products that can maintain excellent quality. TALOAR cares and concerns for our users which is not a slogan, but has permeated into our management decisions and actions.



Concept of Balance Valves

Balance valves are mainly for flow balance control at the terminals and loops of commercial and industrial HVAC systems to tackle hydraulic imbalance. The cooling and heating changes of air-conditioning systems and their operation effect are closely related to the proper application of balance valves. TALOAR's balance technology enables hydraulic balance fully, thus cutting energy consumption, and enhancing heating comfort of air-conditioning systems. Building on this technology, **TALOAR has provided proper product models and technical services for several products, gathering rich project experience.**



H
V
A
C



Indoor Comfort

The hydraulic balancing technology solves problems arising from excessive difference between setting of the air-conditioning system and the actual temperature.

Here is an instance. If the terminal of the piping system that runs in full load under ideal conditions has the actual flow lower than the designed flow, it will cause huge energy waste. If such problem is not rectified, it will cause uneven cooling/heating effects and water unbalancing at the terminals, the system cannot provide the expected performance. TALOAR strongly suggested that all HVAC pipelines should equipped with balancing valves to ensure precise flow measurements, and precise distribution of the flow to all areas within the HVAC system.

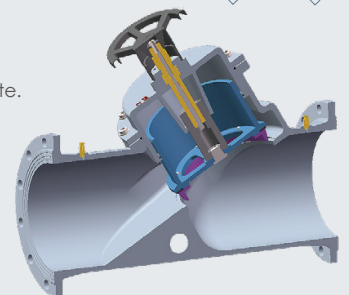

Hydraulic Balance Analysis

Resistance imbalance in local areas of pipelines will cause flow distribution imbalance. An easy solution is to install a hydraulic balance valve that can change its own local resistance in the pipeline then use a special regulating device to regulate system resistance to a balance state.

Pumps in the system as shown right should generate ΔP_{total} pressure differential between both ends of the system to meet 4# demand. However, in this case, 1# pressure differential exceeds the actual value needed, which may result in excessively low/high temperature. Consequently, energy will be wasted.

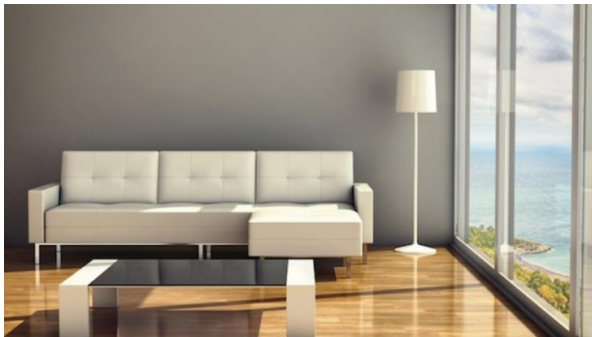
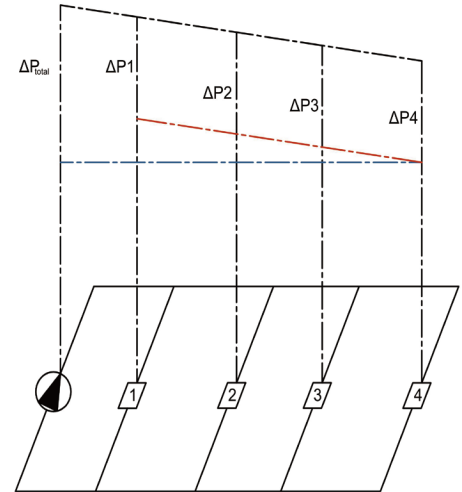

Regulating Principle of Static Balance Valve

The balance valve works to change the resistance of fluid flowing through valves by regulating opening that is related to the gap between the valve disc and seat. In this way, flow is regulated. That is, the balance valve serves as a throttle control with adjustable local resistance. For non-compressible fluid, the flow formula is shown as follows:

$$Q = K_v \sqrt{\Delta P}$$

In the formula, Q stands for flow passing through the balance valve (m³/h); K_v stands for valve resistance coefficient, adjustable; ΔP stands for differential pressure (bar) between both ends of valve.

Balance valve resistance coefficient (K_v) means the flow (m³/h) through balance valve when the differential pressure between both ends of valve is 1 bar (1.02 kgf/cm²). When the opening of the balance valve remains unchanged, K_v will remain the same. That is, K_v depends on the opening of the valve. If K_v values are known under different opening conditions beforehand, flow will be figured out by measuring pressure differential between both ends of the valve. Therefore, the balance valve can be used as the throttle control to regulate flow quantitatively.

Hand-Regulated Balance Regulating Valves

PN25/ 300PSI

TALOAR small-sized brass balance valve adopts low-resistance Y-shaped structure, and its orifice plug is of V-shaped design for better linear regulation. Flow measuring fittings on both ends feature good self-sealing performance and easy adjustment. The highly precise valve disc and favorable sealing performance ensure measurement precision and persistence.

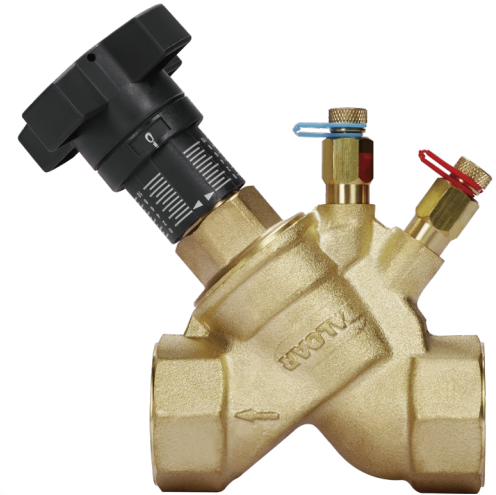

T330
1/2" - 2"

Product Features

- High measurement precision.
- Compact Y-shaped structure, with full flow.
- ON/OFF and regulating functions.
- Regulation memory function.
- Precise digital setting and display.
- Plug-in measuring point, allowing quick connection.



1125 1/4"

Technical Parameters

Pressure Ratings: PN25/350PSI

Working Temperature: -10°C~120°C

Size: 1/2" - 2" , DN15 mm-DN50 mm

End Type: BSPT or NPT

Medium: Water

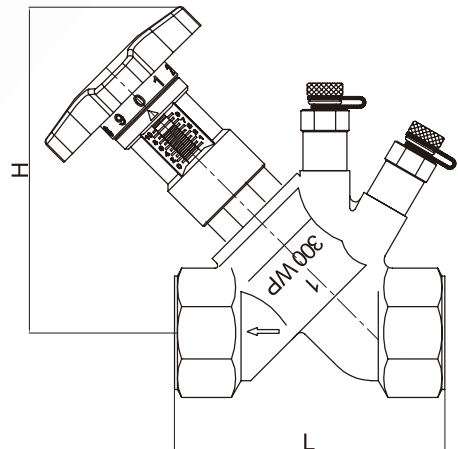

Material Specifications

Body: Brass

Bonnet: Brass

Valve Element: Copper Alloy

Measuring Port: Brass

Seat Seal: PTFE

Handwheel: ABS resin

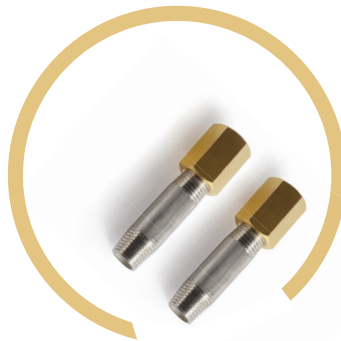

50 mm long stainless steel extension pipe fittings at measuring points are allowed to stretch out of thermal insulation materials of the system.

1126 1/4"

Dimensions/Weights

mm	15	20	25	32	40	50
In	1/2	3/4	1	1 1/4	1 1/2	2
L	80	84	98	110	120	150
H	115	117	118	140	140	150
Kvs	2.76	5.13	8.82	17.03	24.85	35.2
Lbs	1.39	1.50	2.03	2.91	3.53	5.27
kg	0.63	0.68	0.92	1.32	1.60	2.39

* Note: In valve installation, it is strongly required to reserve sufficient space for future and install strainers before the valves to avoid foreign particles blocking to affect valve operations.

Hand-Regulated Balance Regulating Valves

PN16/ 235PSI, PN25/ 350PSI

TALOAR ductile iron flow balance valve adopts low-resistance Y-shaped structure, the shell is coated with epoxy resin. Flow measuring fittings on both ends feature good self-sealing performance and easy adjustment. The highly precise valve core and favorable sealing performance ensure measurement precision and persistence.



F500-D
2½" - 20"

Product Features

- High measurement precision.
- Linear ball valve installed in the front of the measuring point for maintenance
- Plug-in measuring point, allowing quick connection
- Compact Y-shaped structure, with full flow.
- Shut off and regulating functions.
- Regulating memory function.
- Precise digital setting and display.



1125 ¼"

Technical Parameters

Pressure Ratings: PN16/PN25

Working Temperature: -10°C~130°C

Size: 2½" - 20" , DN65 mm-DN500 mm

End Type: ANSI or BSEN flanged

Medium: Water

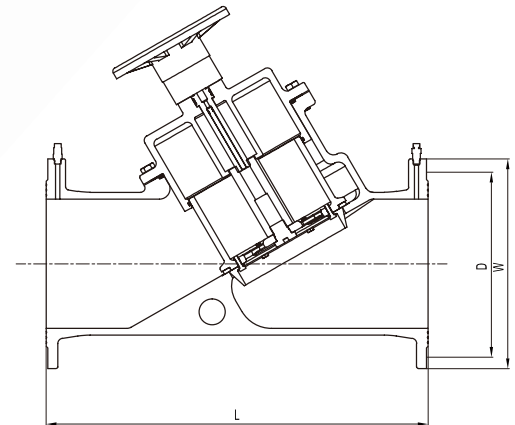

* Note: In valve installation, it is strongly required to reserve sufficient space for future main and install strainers before the valves to avoid foreign particles blocking to affect valve operations.

Material Specifications

Body: Ductile Iron

Bonnet: Ductile Iron

Valve Element: Stainless Steel

Measuring Port: Brass

Seat Seal: EPDM

Handwheel: Nylon



B35 ¼"

The linear brass ball valve with outside screw × inside screw is mounted in the front of the measuring point for ON/OFF or maintenance purpose.

Dimensions/Weights

mm	65	80	100	125	150	200	250	300	350	400	450	500
In	2½	3	4	5	6	8	10	12	14	16	18	20
L	290	310	350	400	480	600	730	850	980	1100	1200	1250
W	185	200	220	250	285	340	405	460	520	580	640	715
D	145	160	180	210	240	295	355	410	470	525	585	650
Kvs	84.9	118	187.4	263.9	400.8	726.9	1087.8	1276.2	2250	3050	3720	4183
Lbs	33	43.0	62	82.7	115.8	218	322	441	662	917	1228	1336
kg	15	19.5	28	37.5	52.5	99	146	200	300	416	557	606

Typical Applications of Balance Regulating Valves

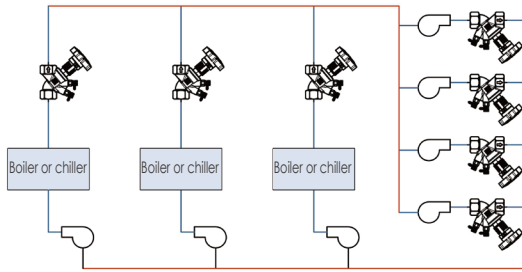

Application in boilers or chillers

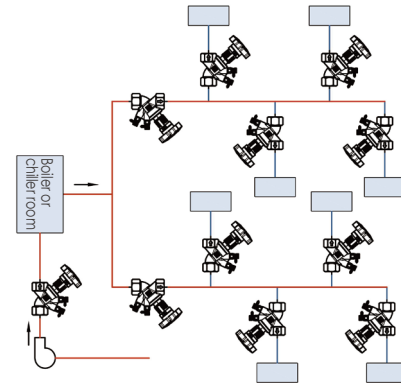

Application in heating (cooling) pipe networks

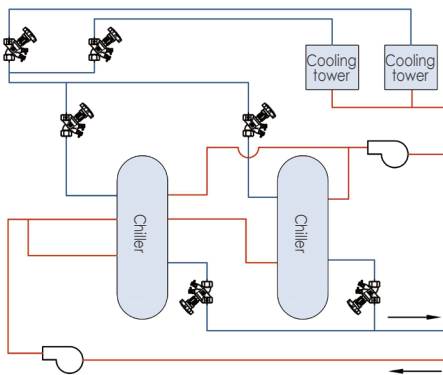

Application in chillers or cooling towers

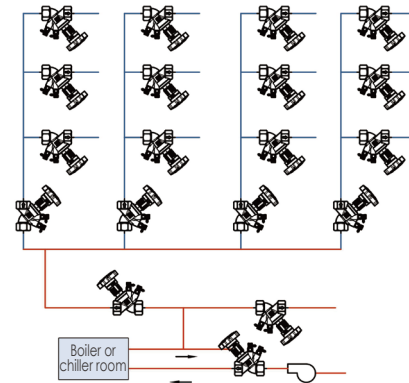

Application in heating (cooling) pipe networks



TALOAR hydraulic balance technology is used in FAW-Volkswagen Plant Project.

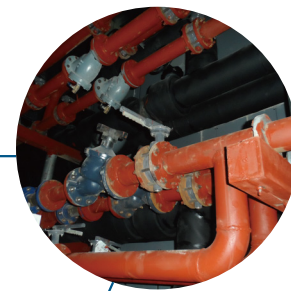

Kv Values of Balance Regulating Valves

DN20mm

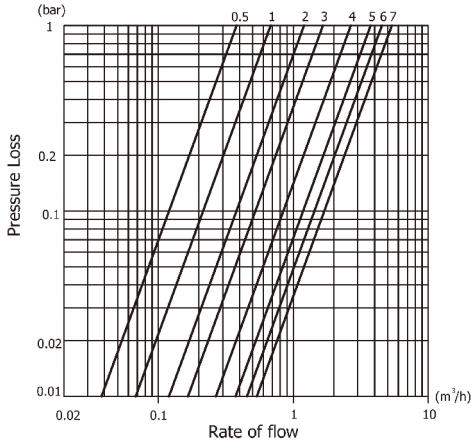

DN25mm

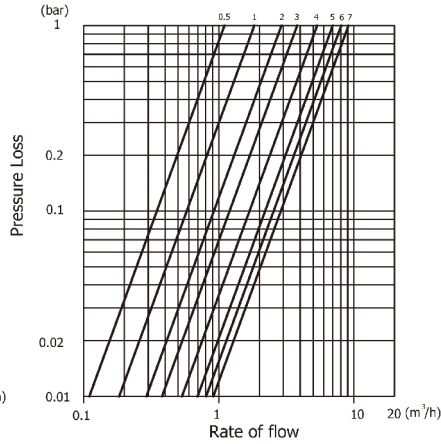

DN32mm

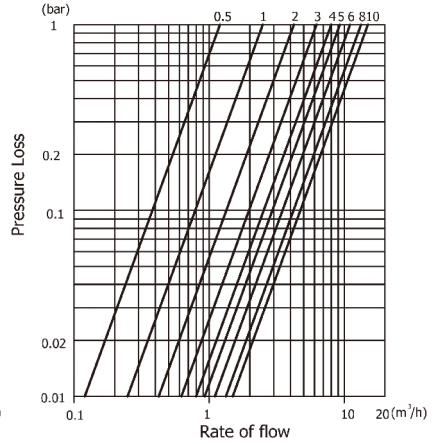

DN40mm

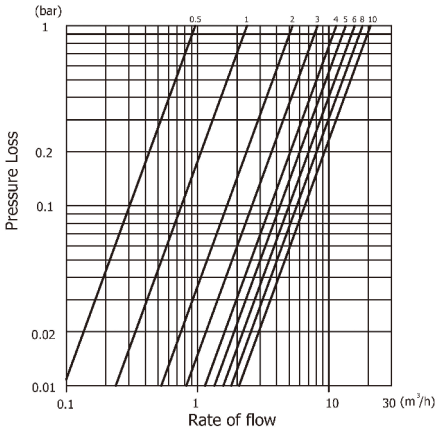

DN50mm

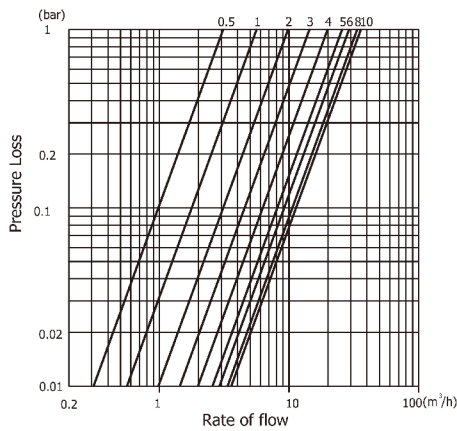

DN65mm

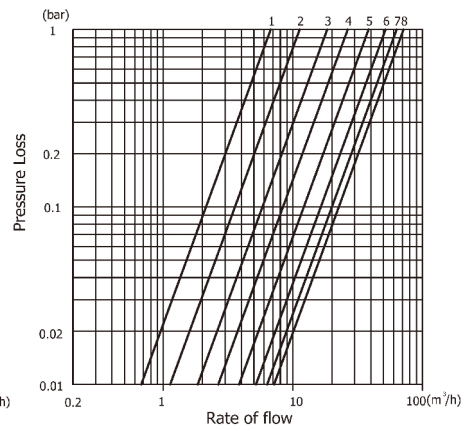

DN80mm

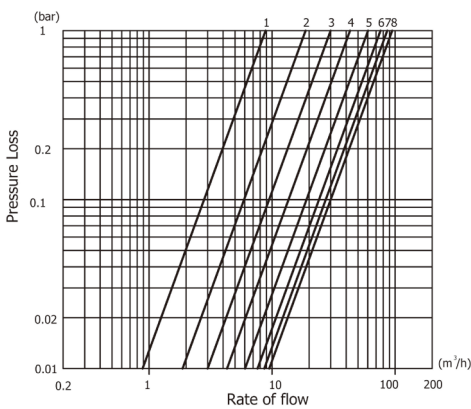

DN100mm

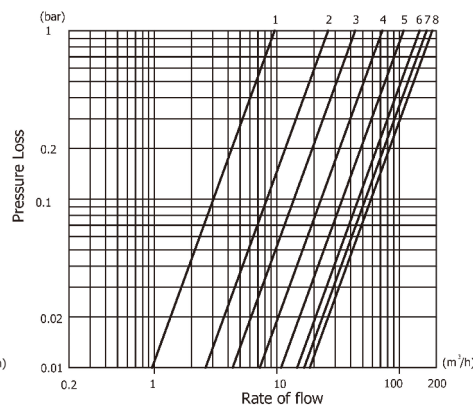

DN125mm

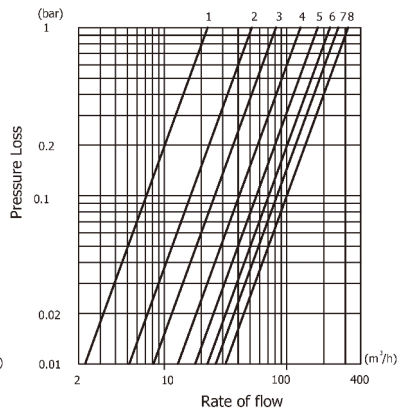

Kv Values of Balance Regulating Valves

DN150mm

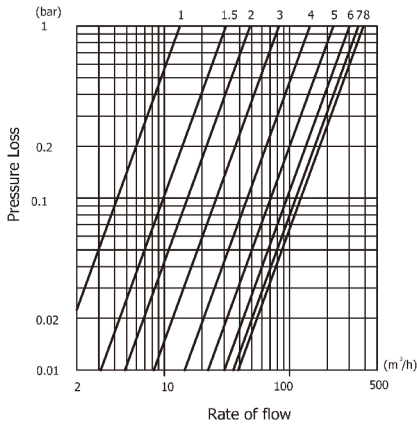

DN200mm

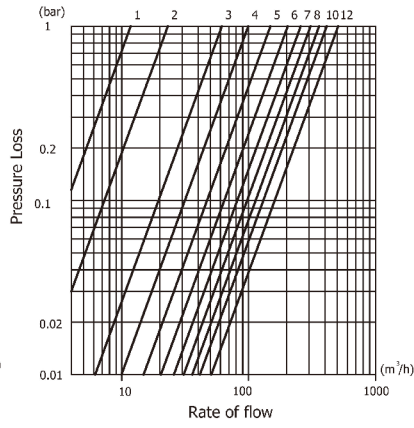

DN250mm

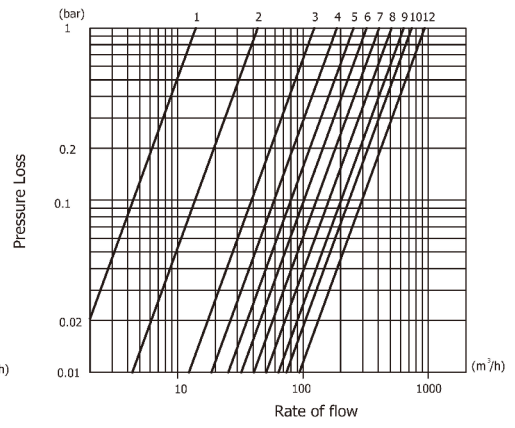

DN300mm

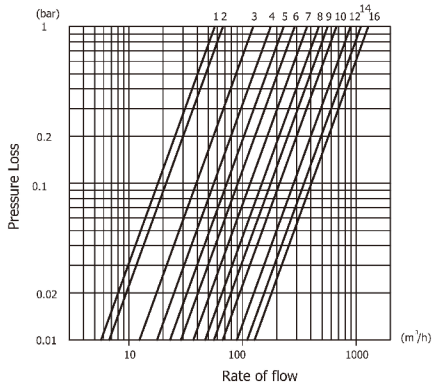

DN350mm

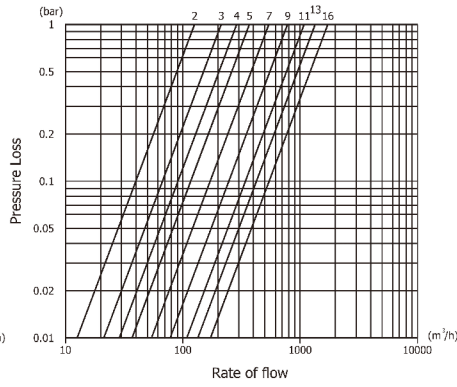

DN400mm

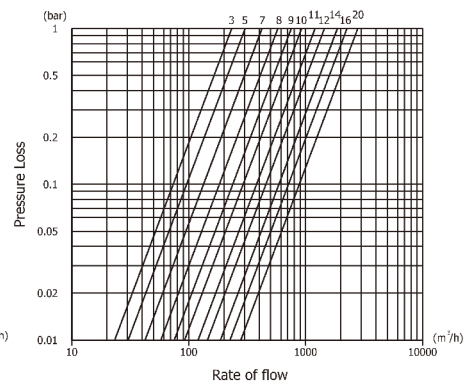

DN450mm

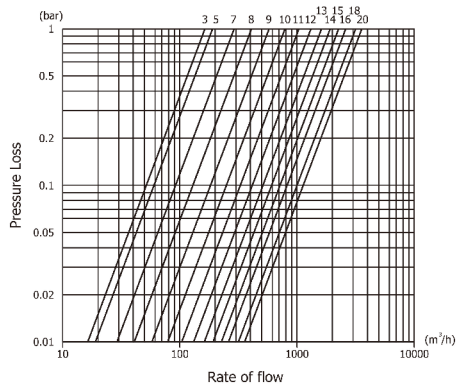

DN500mm

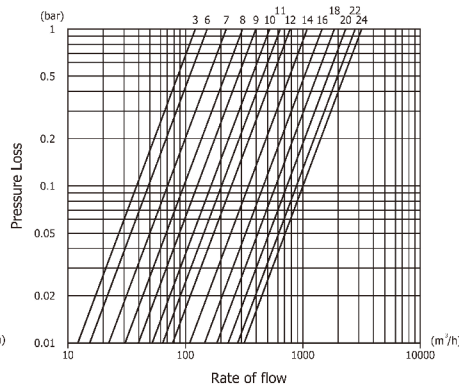

Installation Tips

1. Mounting Location

Balance valves may be mounted either in the water supply pipelines or in the return water pipelines of the air-conditioning riser. It is only needed to mount one balance valve in each riser. It is advisable to mount the balance valve for the main pipe behind the water pump to prevent cavitation due to insufficient pumping capacity of the pump.

2. Mounting Distance

As the balance valve has the flow measuring function, it is required to install the valve to the far end of the straight piping section to ensure stable flow passing into or out of the valve to assure accurate measurement. The upstream and downstream straight piping sections should be 5 times and 2 times the pipe diameter distance to ensure precise measuring values, as shown below.

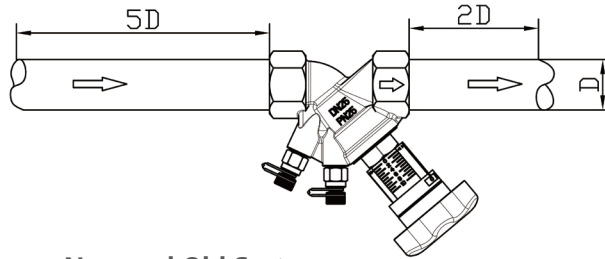

3. Flow Distribution Between New and Old Systems

Balance valve has good regulating function, with resistance coefficient higher than that of the regular globe valve. When the new system with the balance valve is connected to the existing heating (cooling) piping networks, attention should be paid to flow distribution between new and old systems to avoid insufficient flow due to higher water resistance of the new system (or reconstructed system).

4. Do Not Change the Opening of Balance Valves At Will.

After the piping network system is installed and is ready for commissioning, use TALOAR Smart Balancing device to balance the whole system., lock the openings of all valves to achieve hydraulic balance of the system, energy saving and ensure satisfactory heating (cooling) capacity. Do not change the opening of balance valves by regulating the locking locations when the piping network system is working normally.

5. No Need to Install Globe Valves

When overhauling a loop, close the balance valve to "0" position, the balance valve will work as a globe valve instantly to cut off the flow. After overhaul, return the balance valve to the original locking position. Therefore, it is not necessary to install globe valves.

6. Purpose of Extended Measuring Points

Since pipelines are usually protected with thermal insulation materials. There is no room for measuring points at the inlets and outlets of balance valves. In order to stretch the measuring points out of the insulation materials, all large diameter balance valves are made of stainless steel to stretch out of thermal insulation materials. As for the small-diameter balance valves they are connected to ball plug valves to stretch the measuring points out of thermal insulation materials. For transport safety, extension stainless steel measuring points are not directly mounted on the valves, instead packed separately and to be mounted in valves on site. Do not fasten measuring points with brute force to prevent damage to accessories.

Commissioning of Balance Valves

1. System Preparations Before Commissioning

- Valve commissioning is the last task in the system. Before commissioning, clean pipelines to ensure the entire system is free from welding slag, other impurities and particles; vent air by fully open all balance valves; start pumps in the designed maximum number; start variable frequency pumps to 50 Hz/60 Hz so that the system reaches the maximum flow under full load condition.
- Prepare the list of load devices in the system and their flow demands. Number all balance valves to take records when commissioning valves.

2. Commissioning Methods

a) Proportion Method

The increase and decrease of the total flow within the same module will cause the flow of each balance valve in the module to increase or decrease in proportion. Therefore, it is required to regulate all balance valves at the end of the terminal within the module with equal proportion to the designed values and then move on to regulate other modules. After all modules are regulated, then regulate the main valves as one module. Until all valves are regulated to the designed flow values or equal proportion to the designed flow values.

b) Compensation Method

Pick the balance valve at the end of the module as a reference valve, regulate the reference valve to the designed flow value. Regulate another balance valve while keeping an eye if there is any flow change in the reference valve. Use the total flow of the main valve to regulate the flow so as not to affect the flow of the reference valve and so on. When all balance valves within the same module reached the designed flow value, move on to other module. Pick another balance valve and repeat the whole process again until the whole system is regulated!

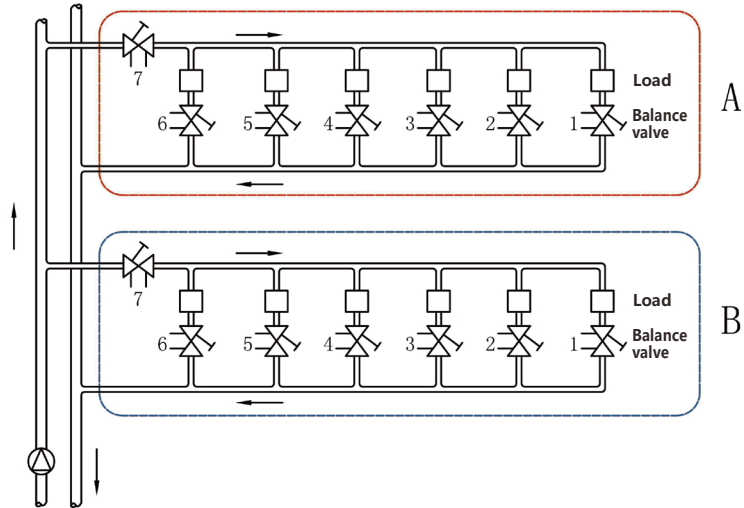

The diagram above shows two modules of an air-conditioning system: Module A and Module B. Each module has 6 risers, each of which carries one load and one balance valve numbered 1, 2, ..., 7# balance valve may be taken as the main valve in the module, and 1# balance valve at the end of the module as the reference valve. By either proportion or compensation method, the reference valve (1#) is regulated to the designed flow then keeps the flow unchanged. The flow of the reference valve (1#) may be affected while other valves are regulated, then adjust 7# valve to keep the flow of the reference valve (1#) unchanged.

3. Limit Stop

After all balance valves are regulated, limit the valve disc to prevent change in the valve opening due to impact by water flow. Three types of TALOAR handwheels come with small round caps in the middle position. Remove the handwheel cap; unscrew the fastening bolt inside; tighten up the limit bolt inside the valve core & stem assembly with a hexagon wrench.

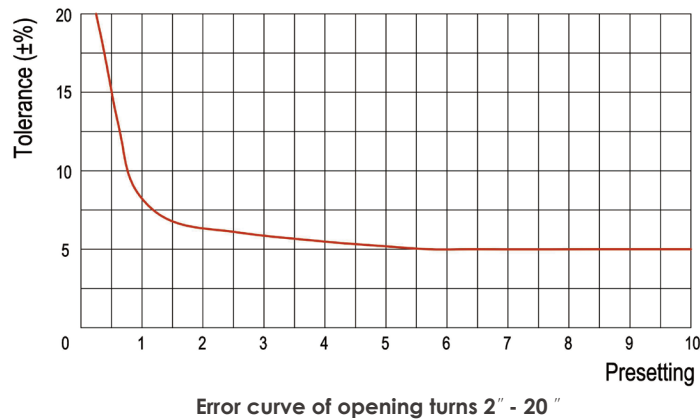

Precise and Ideal Test Reports

- **Measure differential pressure and flow for various balance valves.**
- **Store data for all sizes of balance valves.**
- **Precise pressure differential sensors.**
- **Precise temperature detectors.**
- **Luminous LCDs, with clear display.**
- **Easy operation.**
- **Shock-proof case for easy carrying.**



High Precision Meters

In HVAC systems with hydraulic balance, it is very critical to use meters featuring stable and precise performance. These meters can transmit data of differential pressure, flow and temperature to the computer for accurate regulating.

How to Measure?

1. Fill the sensor with fluid to ensure correct measurement.
2. Ensure the measuring probe is free from blockage.
3. Insert the measuring probe into the measuring point of the balance valve vertically as the probe is subject to bending and breakage.
4. Maximum differential pressure between the first and second measurements by the pressure differential sensor: 12 Bar.
5. Blow gas into the sensor to drain fluid fully and prevent damage due to freezing.
6. Prevent device from falling down, squeezed and under water.



The valves designed and manufactured by TALOAR provide ideal and correct solutions in the recommended application fields at the lowest purchasing and maintenance cost, able to meet and exceed the specified standards developed through years of experience, researches and laboratory testing.



TALOR[®]

TALOR INC.,

1220N. Market Street,
Delaware, USA.
PHONE: +1/302.327.8999
www.taloor.com